

ONE BED

BARCHETTA

432 SQ.FT. • 129 SQ.FT. TERRACE

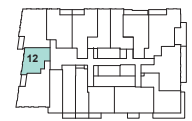
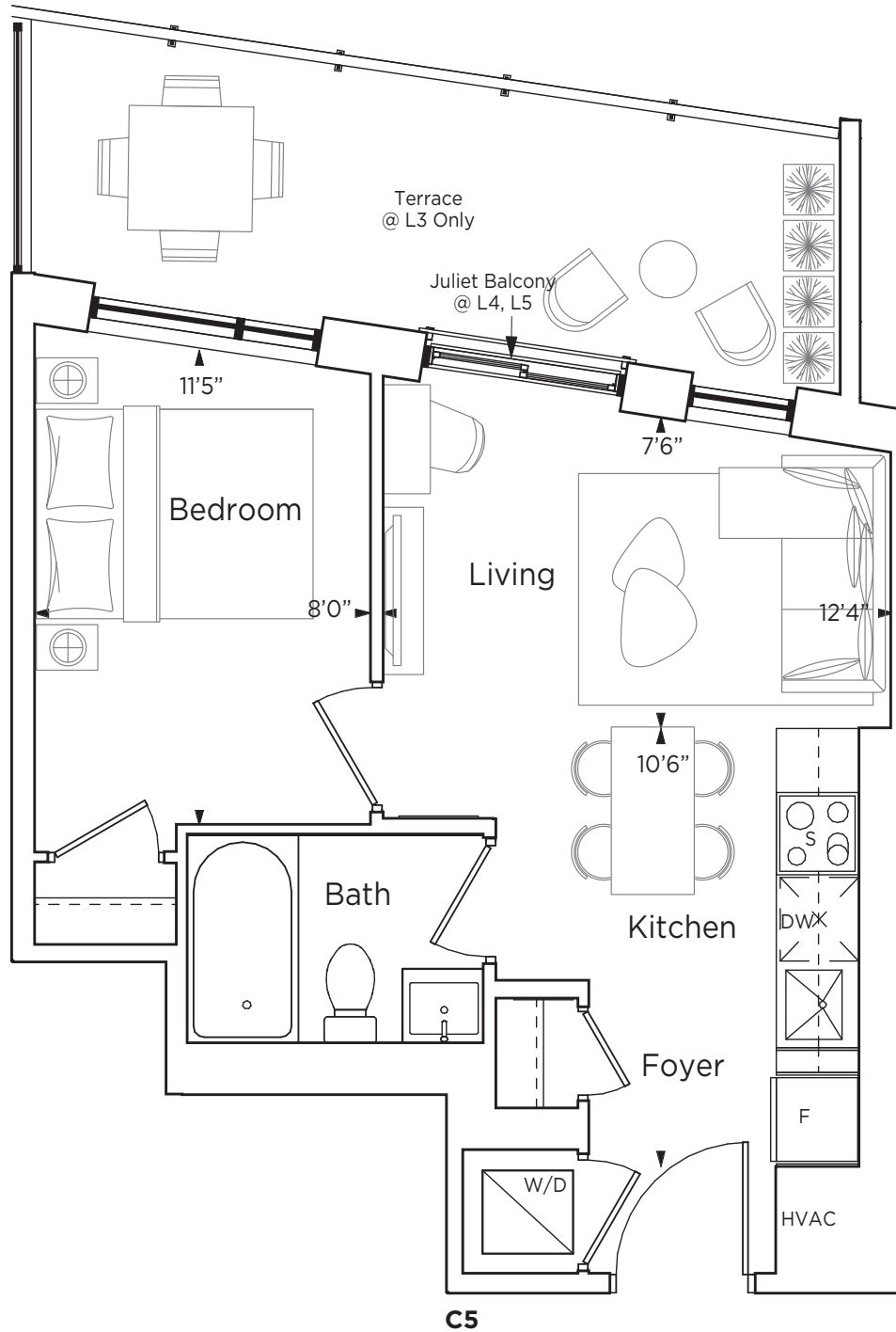

Tower A
LEVEL 5



Tower A
LEVEL 4



Tower A
LEVEL 3



Vincent
CONDOMINIUMS



ONE BED

CARTE BLANCHE

479 SQ.FT. • 43 SQ.FT. BALCONY

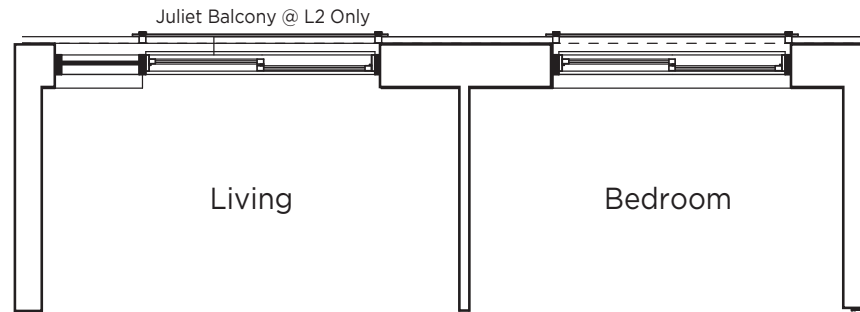

PLAN AT LEVEL 2 - 472 Sq. Ft.

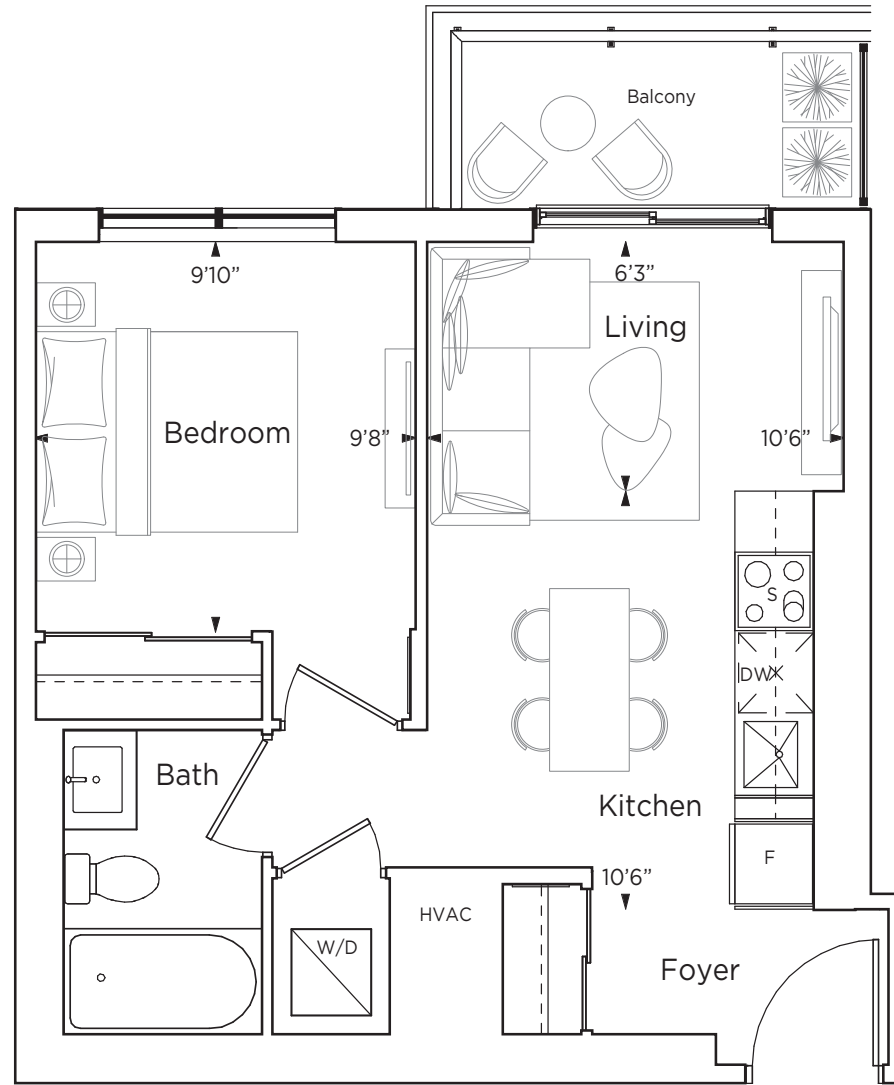

G6

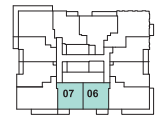

Tower A
LEVEL 15-34

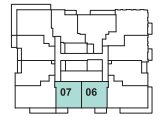

Tower A
LEVEL 7 - 14



Tower A
LEVEL 6



Tower A
LEVEL 5



Tower A
LEVEL 4

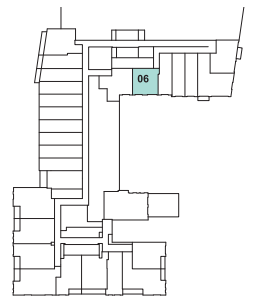

Tower A
LEVEL 2



Vincent
CONDOMINIUMS



ONE BED (BARRIER-FREE)

CHAMPAGNE

518 SQ.FT. • 45 SQ.FT. BALCONY

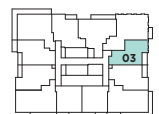
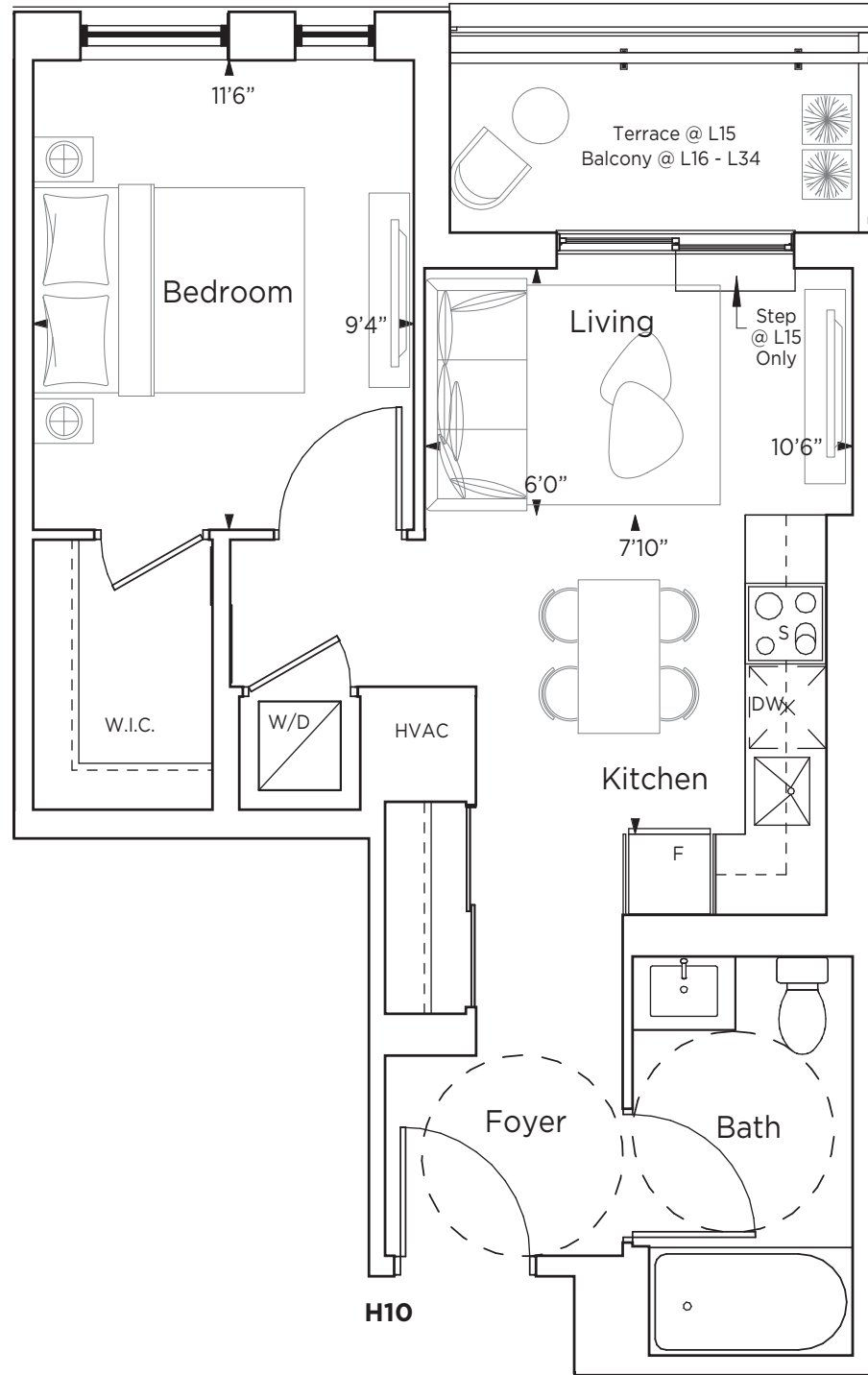

Tower A
LEVEL 15-34

ONE BED + DEN

DIAMOND

557 SQ.FT. • 647 SQ.FT. TERRACE

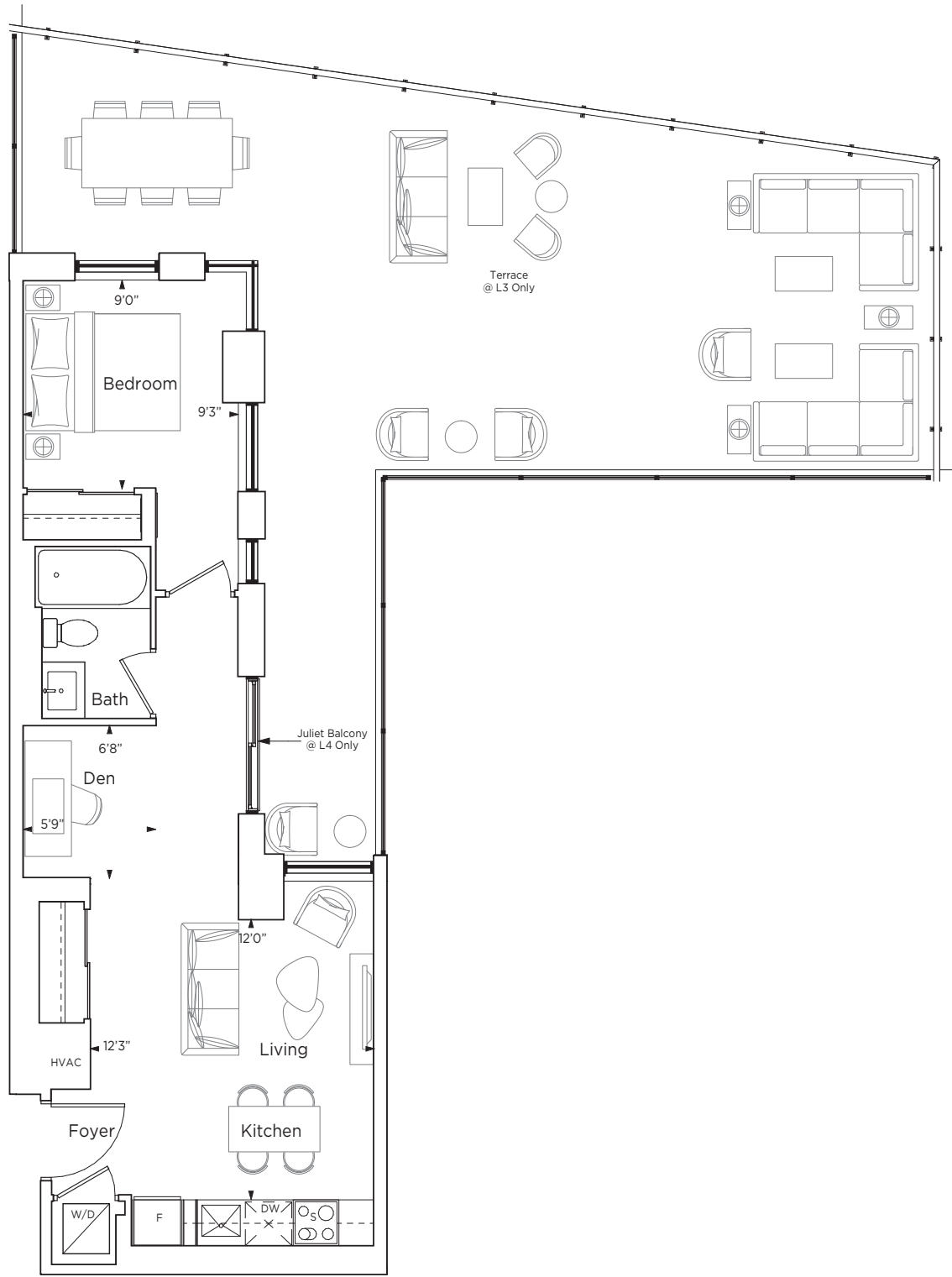

C9



Tower A
LEVEL 4



Tower A
LEVEL 3



Vincent
CONDOMINIUMS



Materials, specifications and floor plans are subject to change. All renderings are artist's concept. All floor plans are approximate dimensions. Actual usable floor space may vary from stated floor area. Balcony/terrace areas may vary. Windows, room/area dimensions & square feet may vary due to location within building. Furniture not included. E. & O. E.

ONE BED + DEN

LANGOUSTE

638 SQ.FT. • 579 SQ.FT. TERRACE

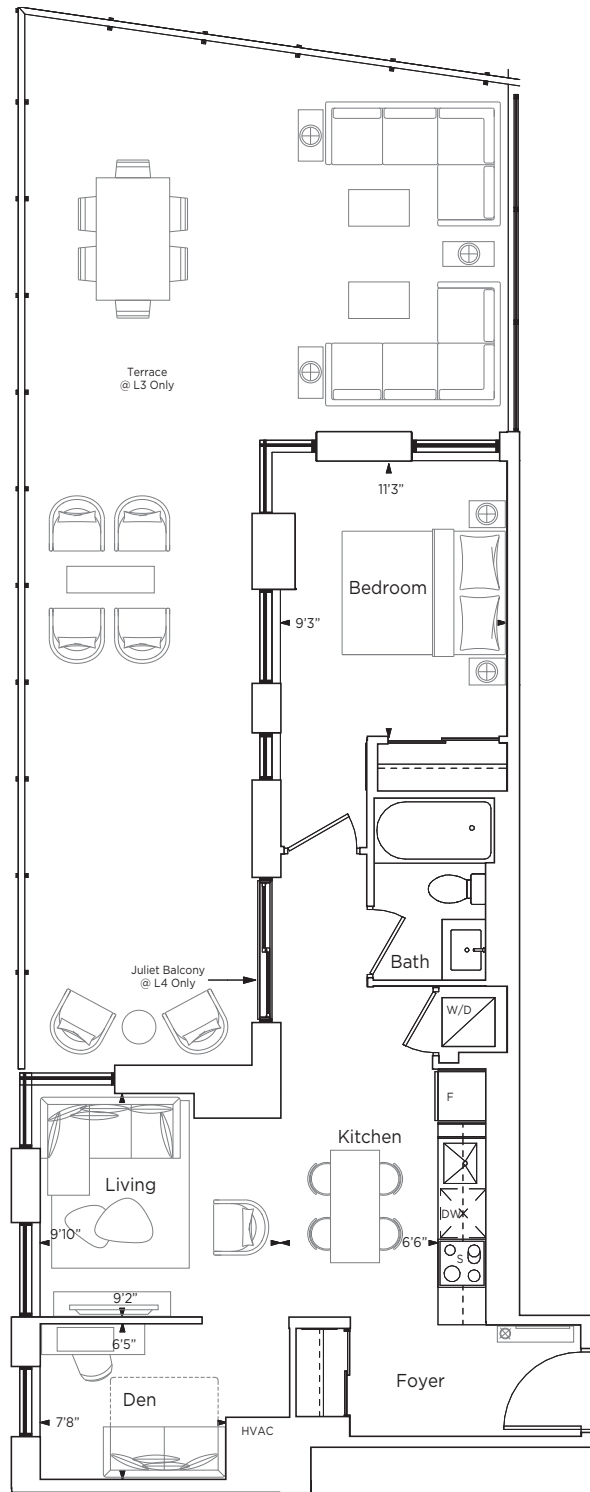

C13



Tower A
LEVEL 4

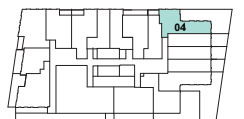

Tower A
LEVEL 3



Vincent
CONDOMINIUMS



ONE BED + DEN (BARRIER-FREE)

LAS VEGAS

655 SQ.FT. • 44 SQ.FT. BALCONY / TERRACE

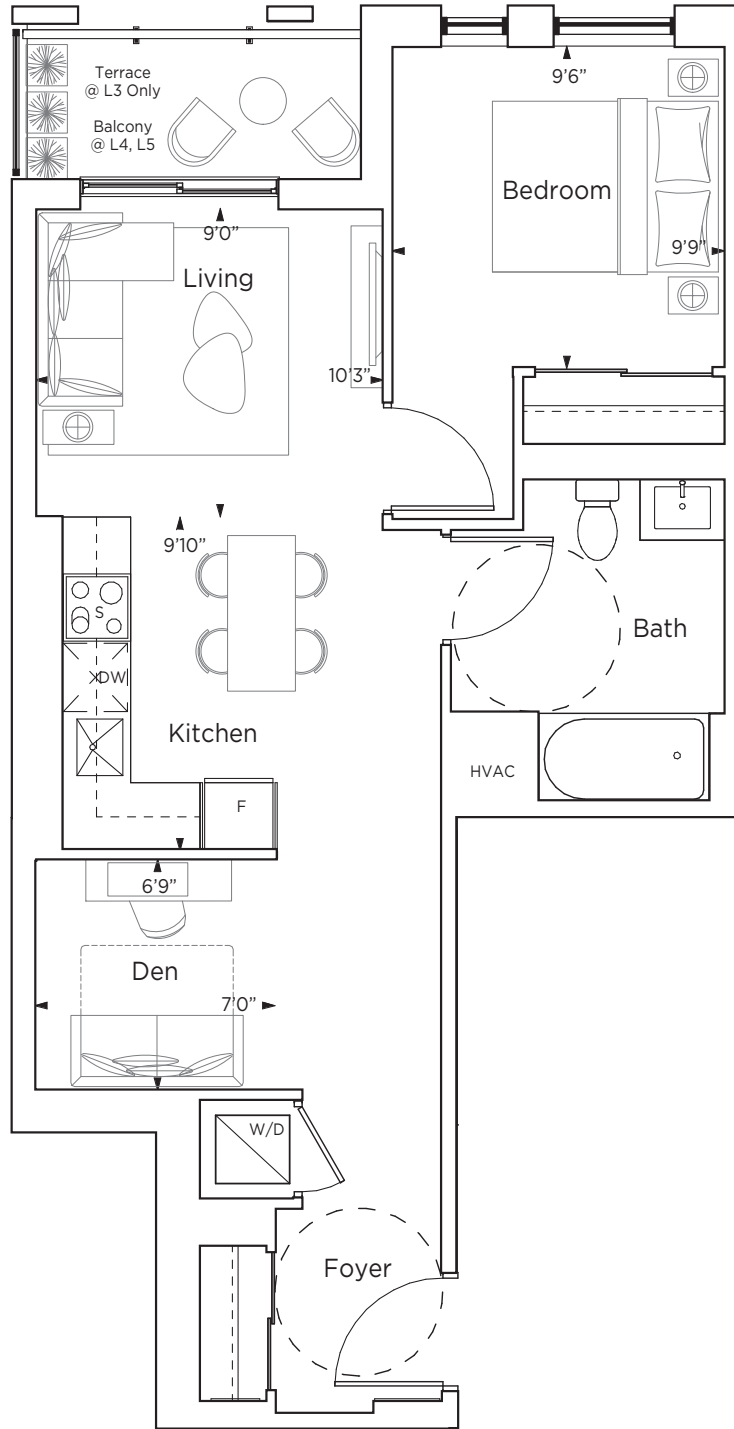

C2

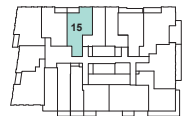

Tower A
LEVEL 5

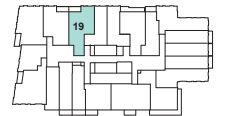

Tower A
LEVEL 4

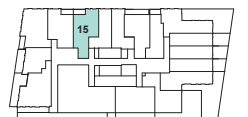

Tower A
LEVEL 3



Vincent
CONDOMINIUMS



TWO BED

LOS ANGELES

699 SQ.FT. • 77 SQ.FT. BALCONY • 165 SQ.FT. TERRACE

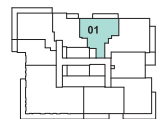
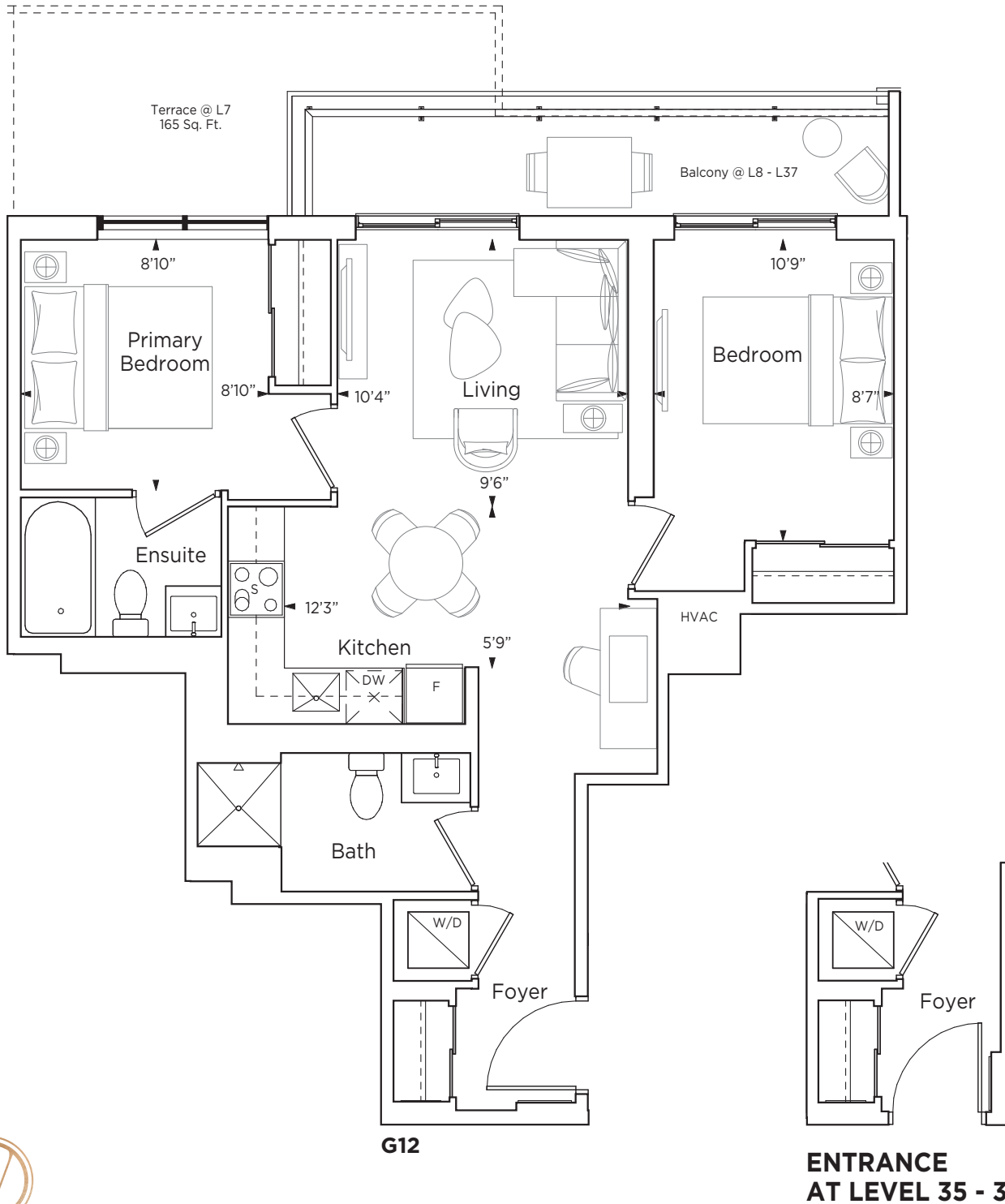

Tower A
LEVEL 35 - 37



Tower A
LEVEL 15 - 34

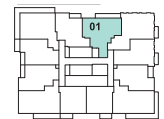

Tower A
LEVEL 8 - 14



Tower A
LEVEL 7



Vincent
CONDOMINIUMS



Materials, specifications and floor plans are subject to change. All renderings are artist's concept. All floor plans are approximate dimensions. Actual usable floor space may vary from stated floor area. Balcony/terrace areas may vary. Windows, room/area dimensions & square feet may vary due to location within building. Furniture not included. E. & O. E.

TWO BED

MONACO

706 SQ.FT.

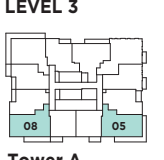
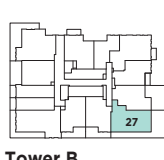
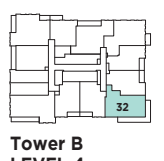
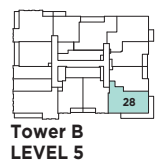
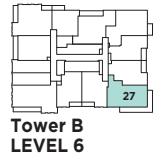
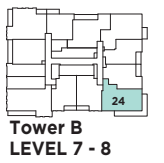
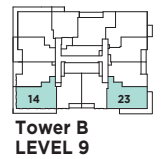
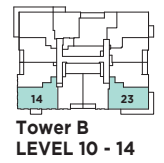
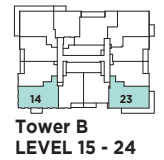
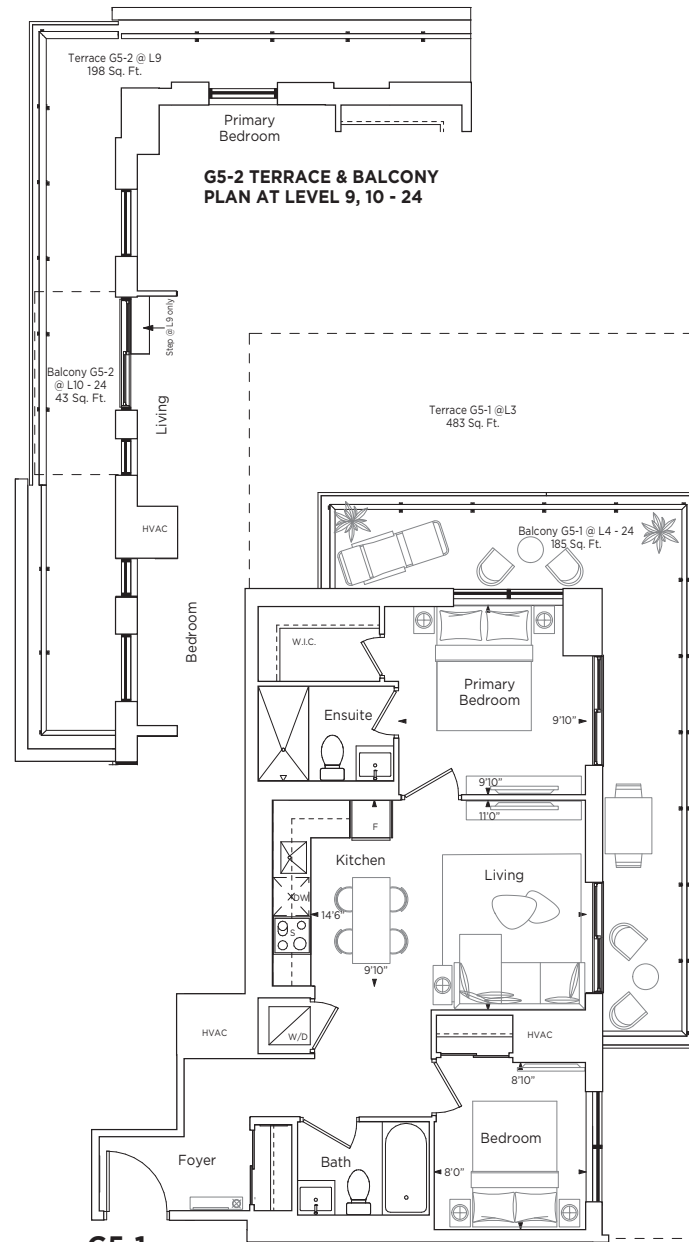
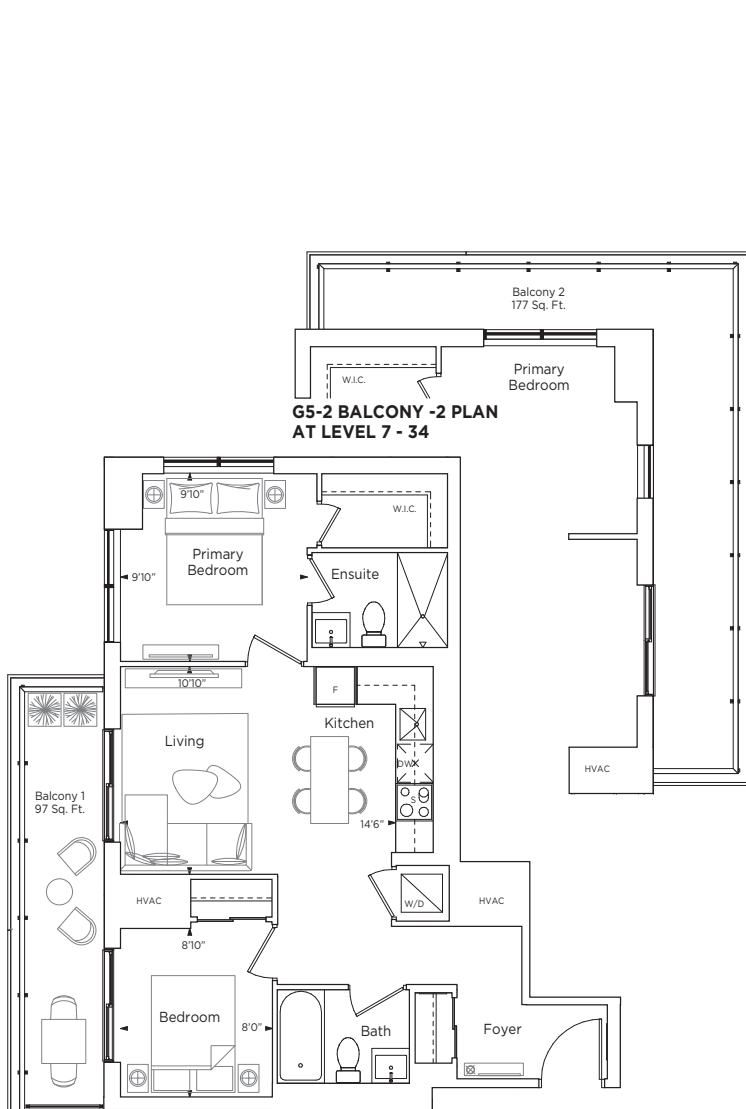

Materials, specifications and floor plans are subject to change. All renderings are artist's concept. All floor plans are approximate dimensions. Actual usable floor space may vary from stated floor area. Balcony/terrace areas may vary. Windows, room/area dimensions & square feet may vary due to location within building. Furniture not included. E. & O. E.

TWO BED

SAVILE ROW

802 SQ.FT. • 146 SQ.FT. TERRACE • 33 SQ.FT. BALCONY

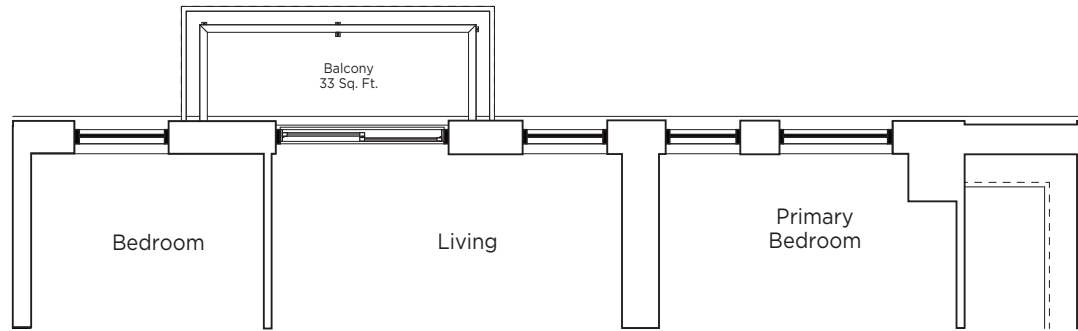

BALCONY PLAN AT LEVEL 6

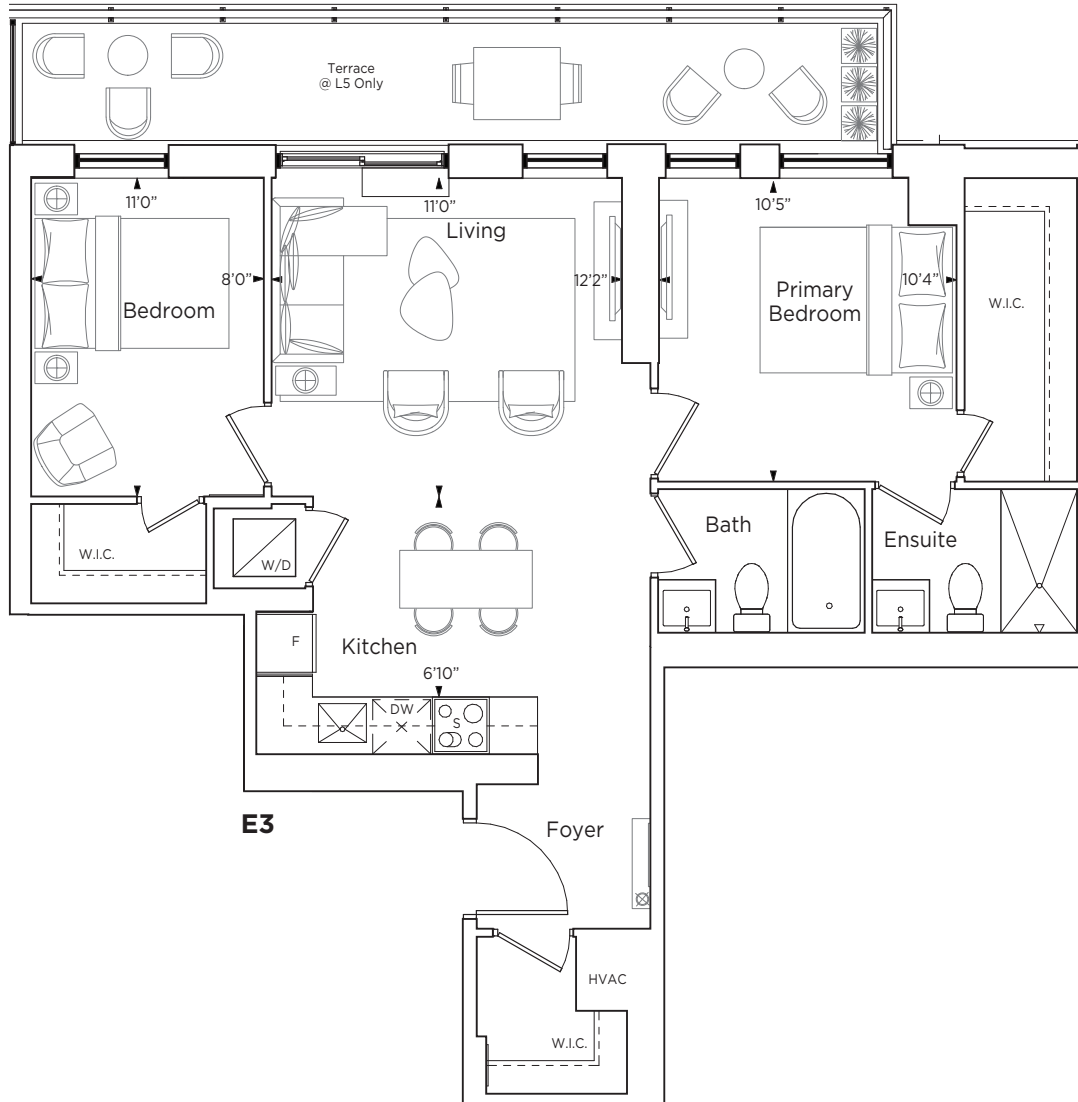

Tower A
LEVEL 6



Tower A
LEVEL 5



Vincent
CONDOMINIUMS

